

# ST. GABRIEL MAUSOLEUM / SHELTER

## SEC. 4 ALL SOULS CEMETERY

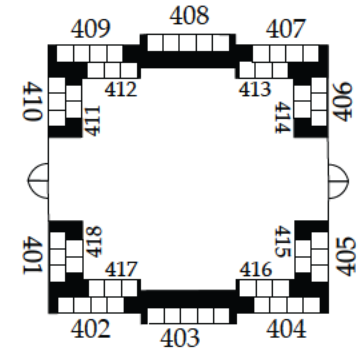

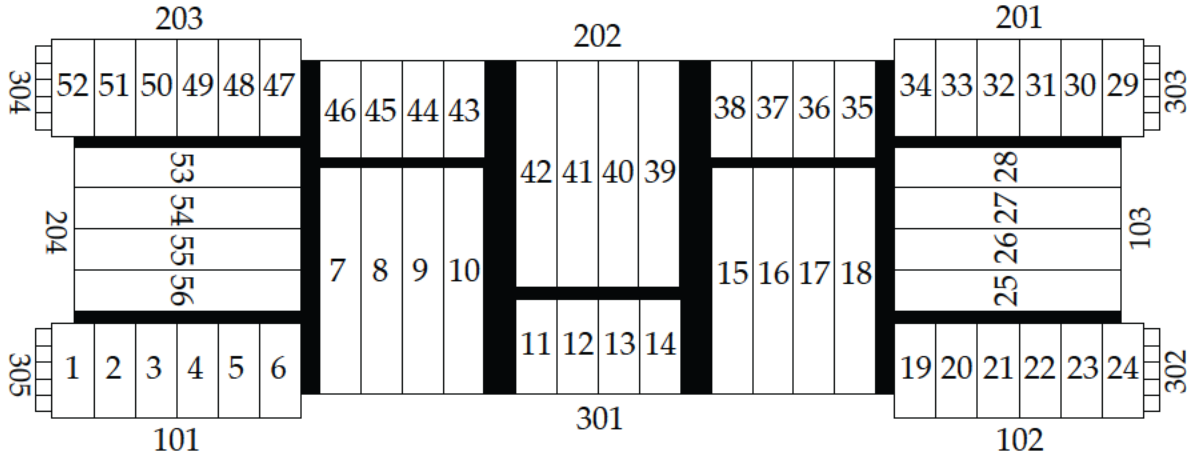

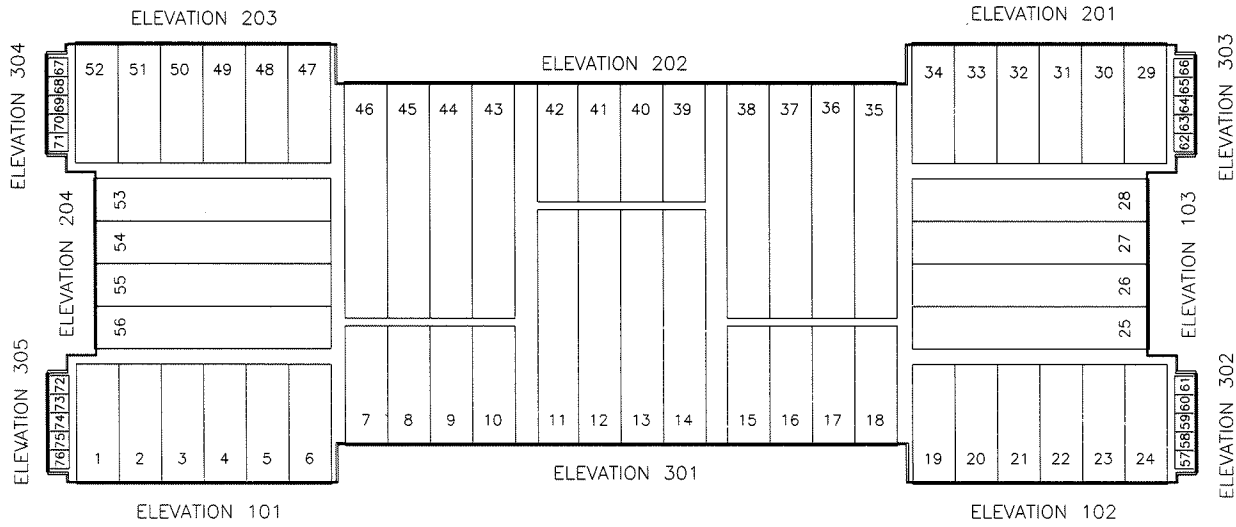

Note:  
 All Crypts are designated and located by row number and tier letter.  
 For example: Crypt 304 – A would be 304 and tier A.

A Designates Floor Level  
 F Designates Ceiling Level

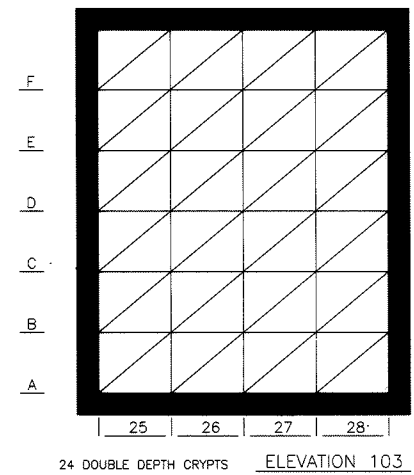
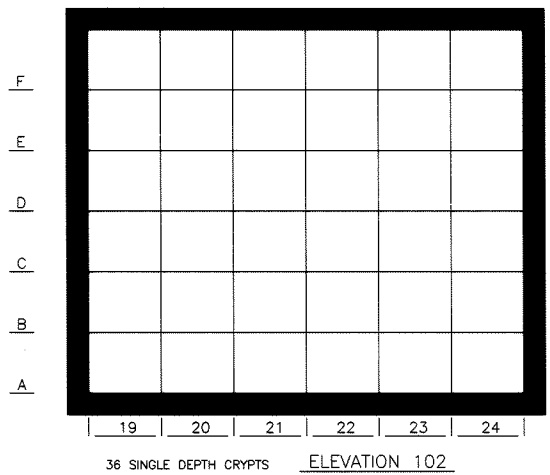
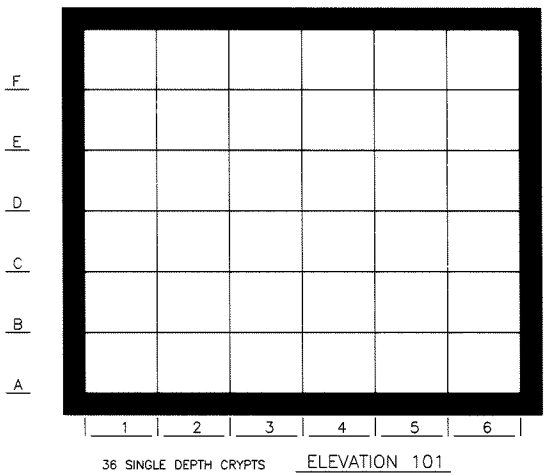

No.		DATE		REVISION	
OFFICE OF DEVELOPMENT Catholic Cemeteries Association 44100 Miller Ave. Cleveland, Ohio 218.841.7375 218.841.8212 FAX: 218.841.8212					
<b>Saint Gabriel the Archangel Mausoleum</b> <b>Section 4</b> <b>All Souls Cemetery</b> Catholic Cemeteries Association 10366 Chardon Road					
SHEET NAME:					
DATE:					
PROJECT No.: 083002-4					

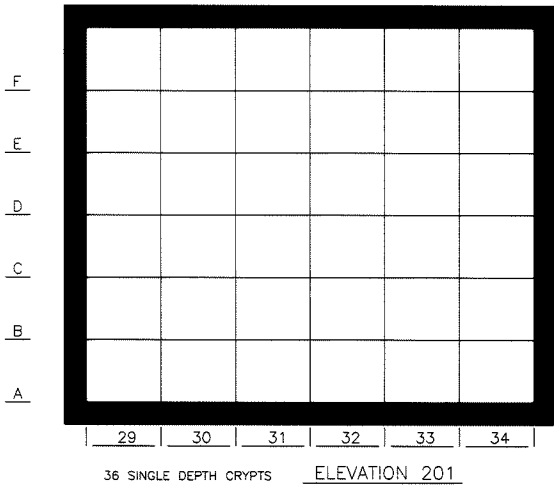

36 SINGLE DEPTH CRYPTS ELEVATION 201

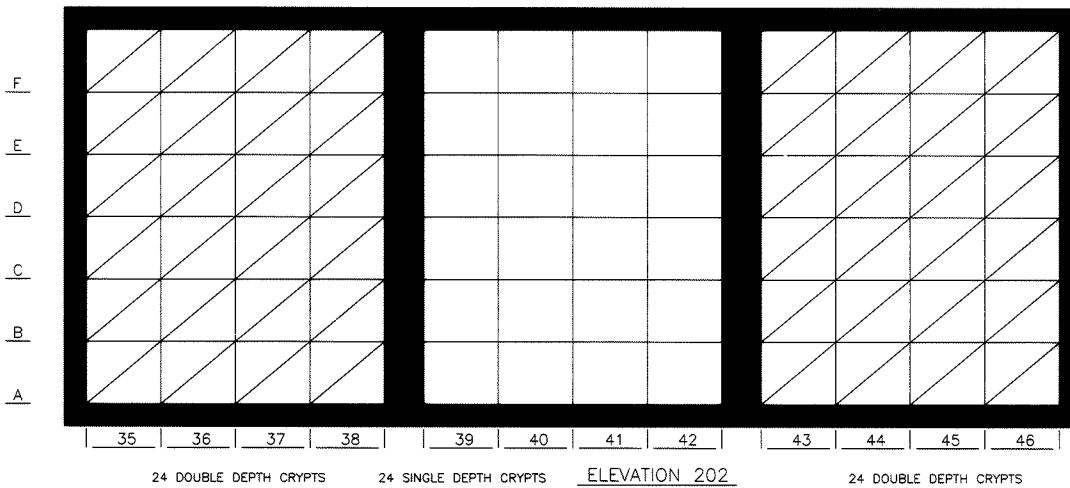

24 DOUBLE DEPTH CRYPTS 24 SINGLE DEPTH CRYPTS ELEVATION 202 24 DOUBLE DEPTH CRYPTS

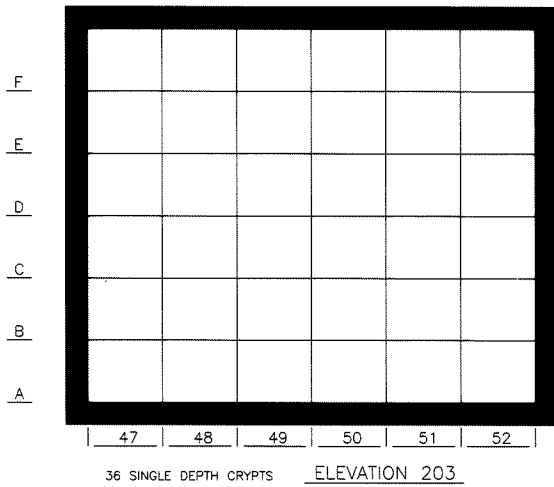

36 SINGLE DEPTH CRYPTS ELEVATION 203

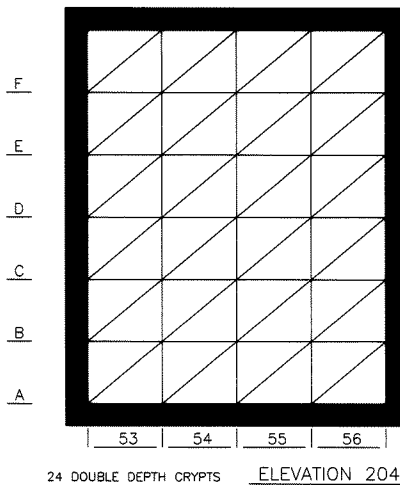

24 DOUBLE DEPTH CRYPTS ELEVATION 204

Note:  
 All Crypts are designated and located by row number and tier letter. For example:  
 Crypt 204 - A would be located in row 204 and tier A.

A Designates Floor Level  
 F Designates Ceiling Level

No.	DATE	REVISION	M
			L
			K
			J
OFFICE OF DEVELOPMENT Catholic Cemeteries Association 18988 Miles Ave. Cleveland, Ohio 44185 216.841.7875 FAX: 216.841.8212			I
Saint Gabriel the Archangel Mausoleum Section 4 All Souls Cemetery Catholic Cemeteries Association 10966 Chardon Road			H
SHEET NAME:			G
DATE:			F
PROJECT No.: 083002-4			E
			D
			C
			B
			A



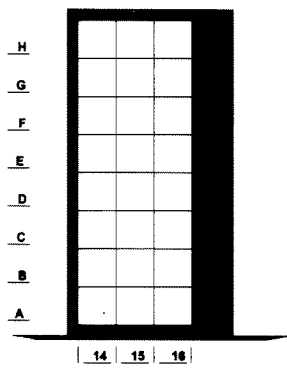
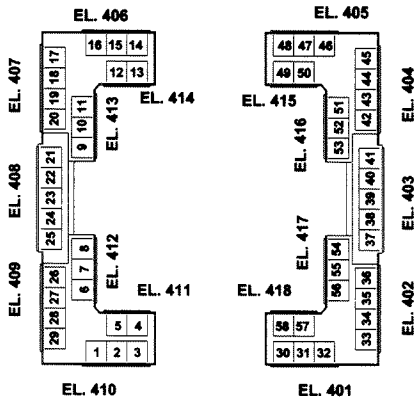

24 UNIT NICHE CABINET  
ELEVATION 406

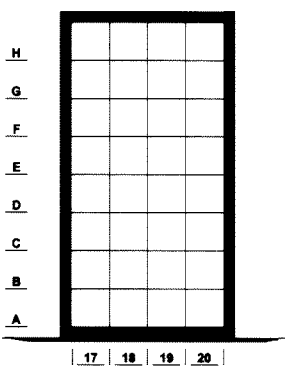

32 UNIT NICHE CABINET  
ELEVATION 407

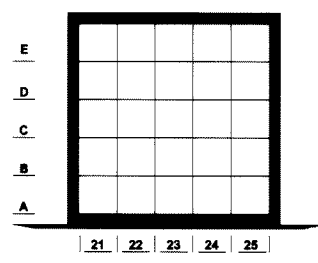

25 UNIT NICHE CABINET  
ELEVATION 408

**NOTE:**  
All niches are designated and located by row number and tier letter.  
For example: Niche 18 - A would be located in row 18 and tier A.

**Summary**  
217 Niches

**A Designates Floor Level**  
**F Designates Ceiling Level**

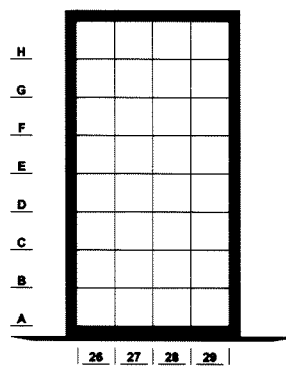

32 UNIT NICHE CABINET  
ELEVATION 409

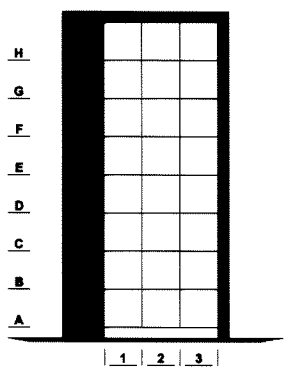

24 UNIT NICHE CABINET  
ELEVATION 410

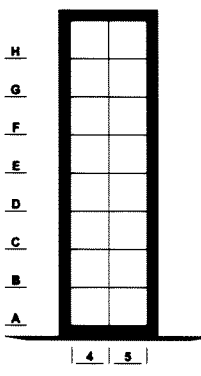

16 UNIT NICHE CABINET  
ELEVATION 411

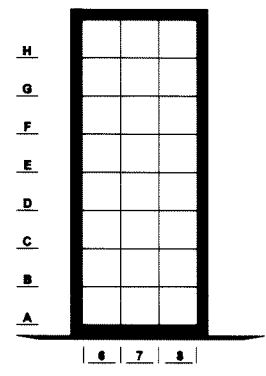

24 UNIT NICHE CABINET  
ELEVATION 412

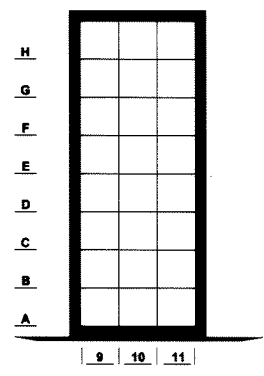

24 UNIT NICHE CABINET  
ELEVATION 413

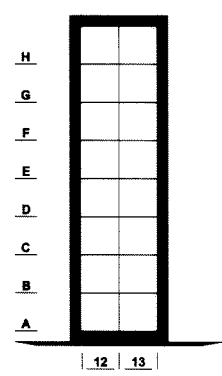

16 UNIT NICHE CABINET  
ELEVATION 414

No.	DATE	REVISION	I	H	G	F	E	D	C	B	A	M
OFFICE OF DEVELOPMENT Catholic Cemeteries Association 19000 Miles Ave. Cleveland, Ohio 44105 216.841.7575 FAX: 216.841.0212												
Saint Gabriel the Archangel Mausoleum Section 4 All Souls Cemetery Catholic Cemeteries Association 10366 Chardon Road												
SHEET NAME:												
DATE:												
PROJECT No.: 063002-4												

